



| | LCC110 | Units |
|---------------------|---------------|--------------|
| Load Voltage | 350 | V |
| Load Current | 120 | mA |
| Max R _{ON} | 35 | Ω |

Description

LCC110 is a 350V, 120mA, 35Ω 1-Form-C relay. It is ideal for applications focused on peak load voltage handling capabilities.

Features

- Small 8 Pin DIP Package
- Low Drive Power Requirements (TTL/CMOS Compatible)
- No Moving Parts
- High Reliability
- Arc-Free With No Snubbing Circuits
- 3750V_{RMS} Input/Output Isolation
- FCC Compatible
- VDE Compatible
- No EMI/RFI Generation
- Machine Insertable, Wave Solderable
- Current Limiting, Surface Mount and Tape & Reel Versions Available

Applications

- Telecommunications
 - Telecom Switching
 - Tip/Ring Circuits
 - Hookswitch
 - Dial Pulsing
 - Ground Start
 - Ringer Injection
- Instrumentation
 - Multiplexers
 - Data Acquisition
 - Electronic Switching
 - I/O Subsystems
 - Meters (Watt-Hour, Water, Gas)
- Medical Equipment-Patient/Equipment Isolation
- Security
- Aerospace
- Industrial Controls

Approvals

- UL Recognized: File Number E76270
- CSA Certified: File Number LR 43639-10
- BSI Certified:
 - BS EN 60950:1992 (BS7002:1992) Certificate #:7344
 - BS EN 41003:1993 Certificate #:7344

Ordering Information

| Part # | Description |
|---------------|---------------------------------|
| LCC110 | 8 Pin DIP (50/Tube) |
| LCC110P | 8 Pin Flatpack (50/Tube) |
| LCC110PTR | 8 Pin Flatpack (1000/Reel) |
| LCC110S | 8 Pin Surface Mount (50/Tube) |
| LCC110STR | 8 Pin Surface Mount (1000/Reel) |

Pin Configuration

LCC110 Pinout

AC/DC Configuration

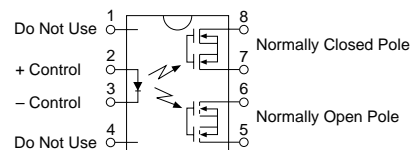

Switching Characteristics of Normally Open (Form A) Devices

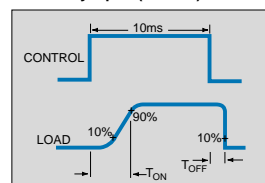

Switching Characteristics of Normally Closed (Form B) Devices

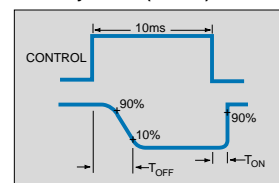

Absolute Maximum Ratings (@ 25° C)

| Parameter | Min | Typ | Max | Units |
|--|------|-----|------------------|------------------|
| Input Power Dissipation | - | - | 150 ¹ | mW |
| Input Control Current | - | - | 50 | mA |
| Peak (10ms) | - | - | 1 | A |
| Reverse Input Voltage | - | - | 5 | V |
| Total Power Dissipation | - | - | 800 ² | mW |
| Isolation Voltage | | | | |
| Input to Output | 3750 | - | - | V _{RMS} |
| Operational Temperature | -40 | - | +85 | °C |
| Storage Temperature | -40 | - | +125 | °C |
| Soldering Temperature | | | | |
| DIP Package | - | - | +260 | °C |
| Surface Mount Package (10 Seconds Max.) | - | - | +220 | °C |

¹ Derate Linearly 1.33 mW/°C

² Derate Linearly 6.67 mW/°C

Absolute Maximum Ratings are stress ratings. Stresses in excess of these ratings can cause permanent damage to the device. Functional operation of the device at these or any other conditions beyond those indicated in the operational sections of this data sheet is not implied. Exposure of the device to the absolute maximum ratings for an extended period may degrade the device and effect its reliability.

Electrical Characteristics

| Parameter | Conditions | Symbol | Min | Typ | Max | Units |
|--------------------------------------|--|-------------------|------|-----|-----|------------------|
| Output Characteristics @ 25°C | | | | | | |
| Load Voltage (Peak) | - | V _L | - | - | 350 | V |
| Load Current* (Continuous) | - | I _L | - | - | 120 | mA |
| AC/DC Configuration | - | I _L | - | - | 120 | mA |
| Peak Load Current | 10ms | I _{LPK} | - | - | 350 | mA |
| On-Resistance | | | | | | |
| AC/DC Configuration | I _L =120mA | R _{ON} | - | 23 | 35 | Ω |
| Off-State Leakage Current | V _L =350V | I _{LEAK} | - | - | 1 | μA |
| Switching Speeds | | | | | | |
| Turn-On | I _F =8mA, V _L =10V | T _{ON} | - | - | 4 | ms |
| Turn-Off | I _F =8mA, V _L =10V | T _{OFF} | - | - | 4 | ms |
| Output Capacitance | 50V; f=1MHz | C _{OUT} | - | 25 | - | pF |
| Capacitance | | | | | | |
| Input to Output | - | 3 | - | pF | | |
| Input Characteristics @ 25°C | | | | | | |
| Input Control Current | I _L =120mA | I _F | 8 | - | 50 | mA |
| Input Dropout Current | - | I _F | 0.4 | 0.7 | - | mA |
| Input Voltage Drop | I _F =8mA | V _F | 0.9 | 1.2 | 1.4 | V |
| Reverse Input Voltage | - | V _R | - | - | 5 | V |
| Reverse Input Current | V _R =5V | I _R | - | - | 10 | μA |
| Common Characteristics @ 25°C | | | | | | |
| Input to Output Capacitance | - | C _{I/O} | - | 3 | - | pF |
| Input to Output Isolation | - | V _{I/O} | 3750 | - | - | V _{RMS} |

*NOTE: If both poles operate simultaneously load current must be derated so as not to exceed the package power dissipation value.

PERFORMANCE DATA*

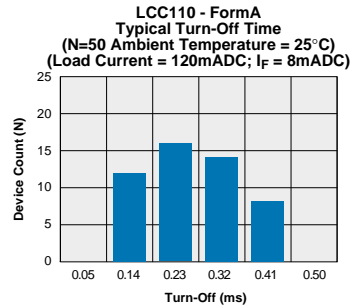
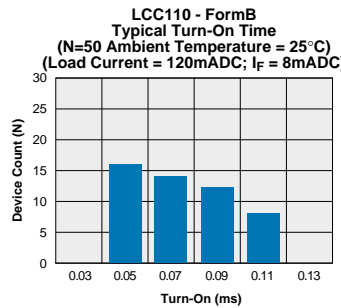
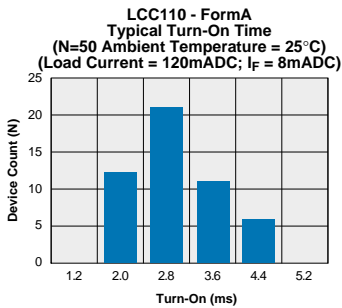
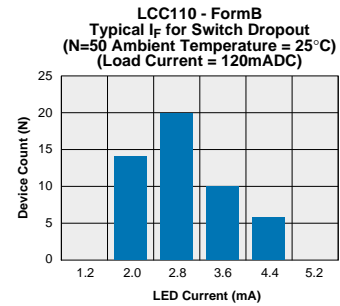
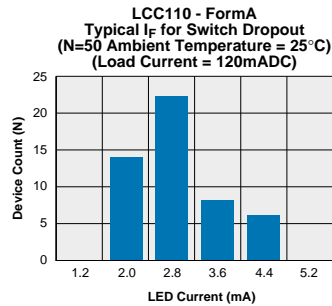
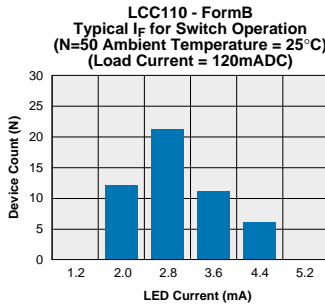
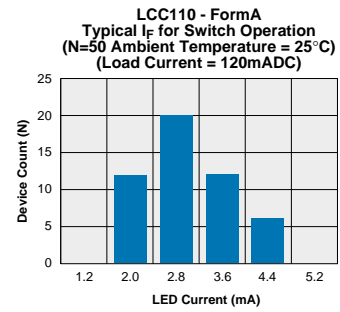
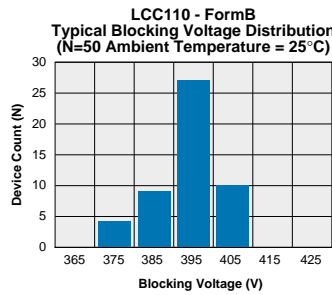
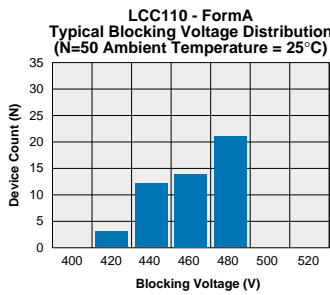
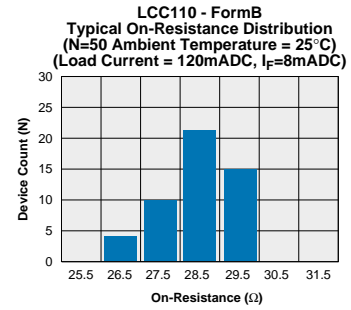
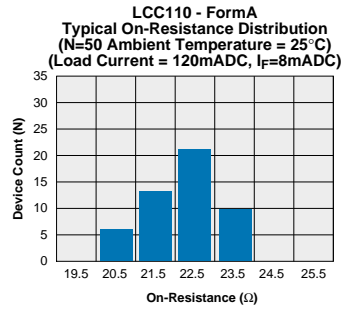
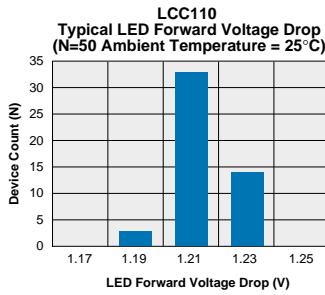

The Performance data shown in the graphs above is typical of device performance. For guaranteed parameters not indicated in the written specifications, please contact our application department.

PERFORMANCE DATA*

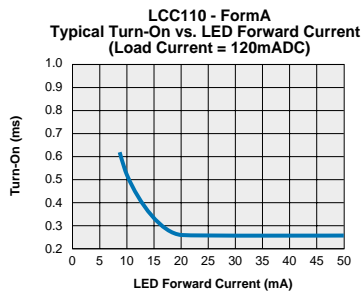
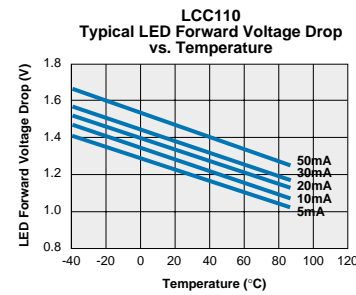
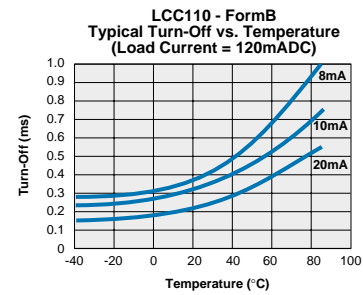
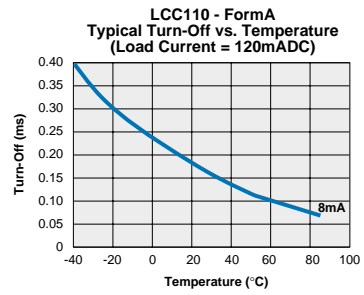
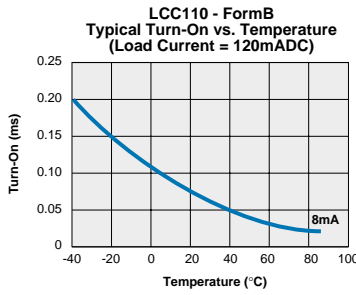
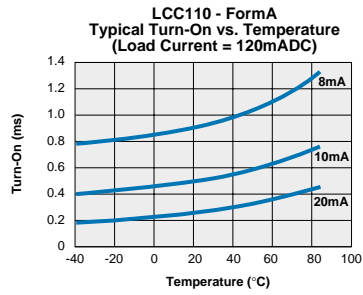
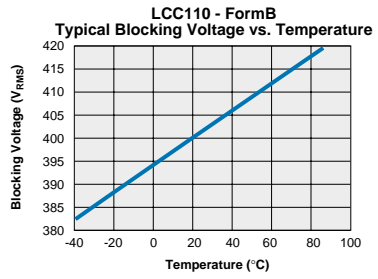
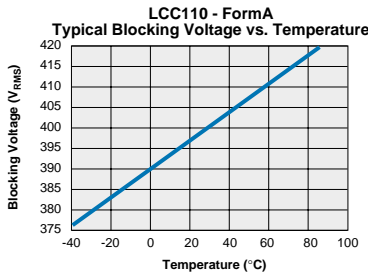
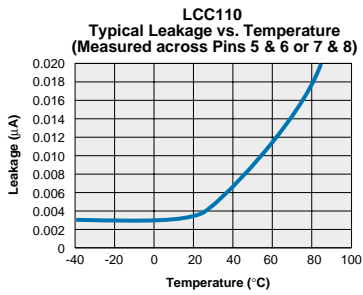
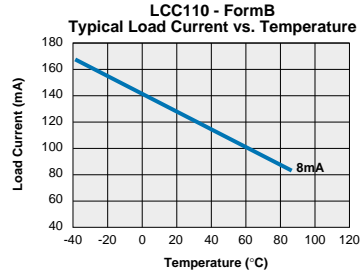
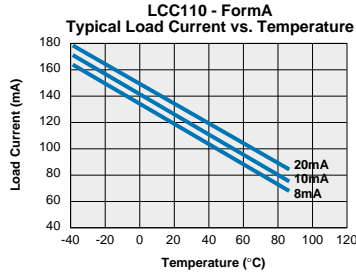
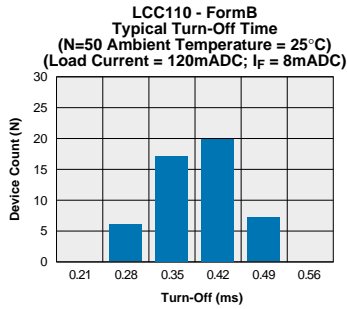

*The Performance data shown in the graphs above is typical of device performance. For guaranteed parameters not indicated in the written specifications, please contact our application department.

PERFORMANCE DATA*

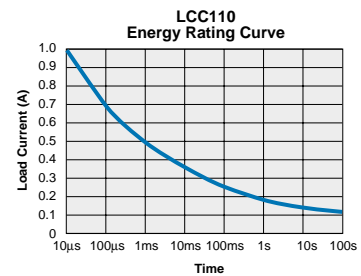
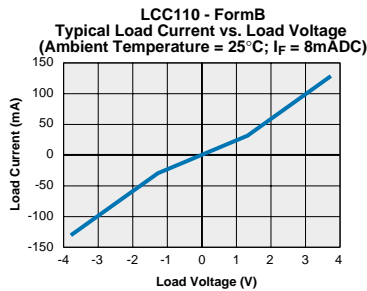
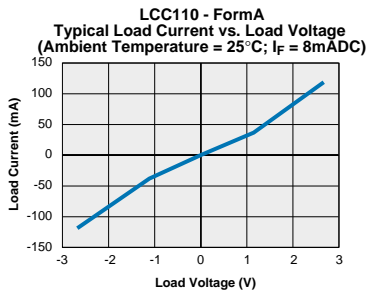
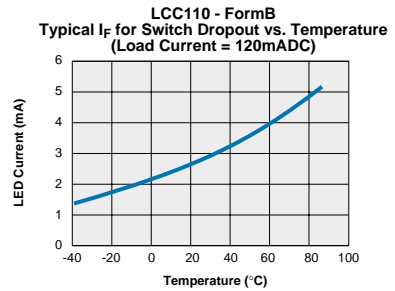
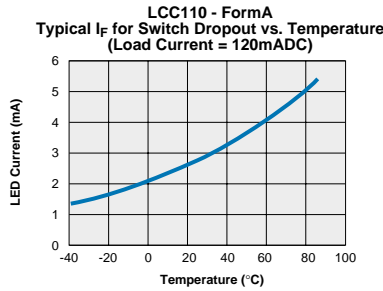
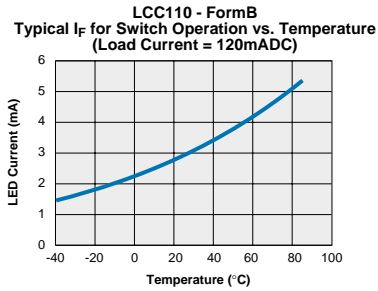
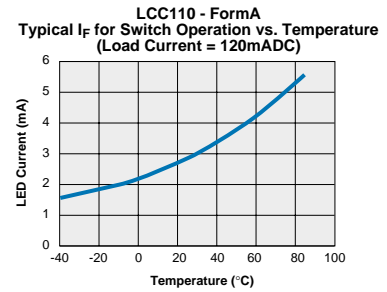
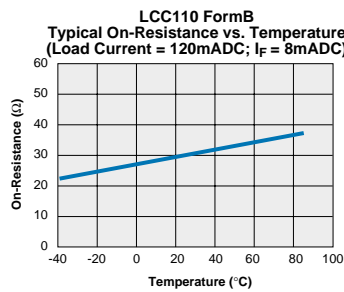
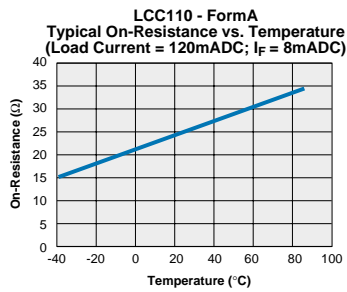
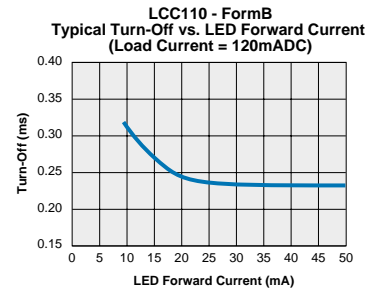
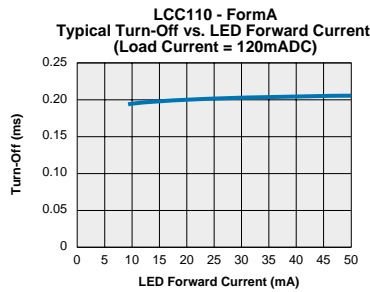
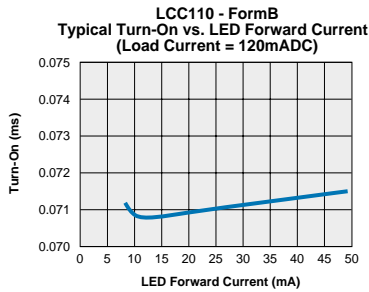

*The Performance data shown in the graphs above is typical of device performance. For guaranteed parameters not indicated in the written specifications, please contact our application department.

Mechanical Dimensions

8 Pin DIP Through Hole (Standard)

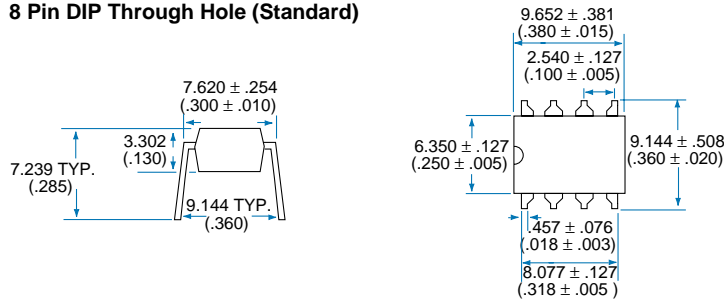

PC Board Pattern (Top View)

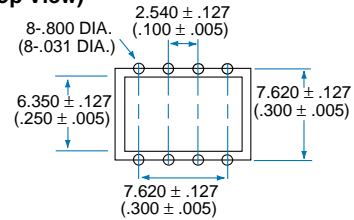

8 Pin DIP Surface Mount ("S" Suffix)

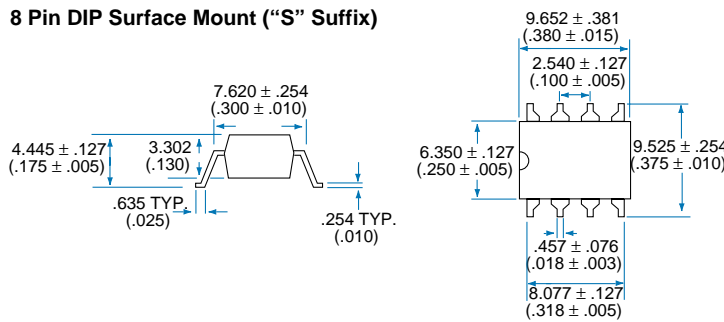

PC Board Pattern (Top View)

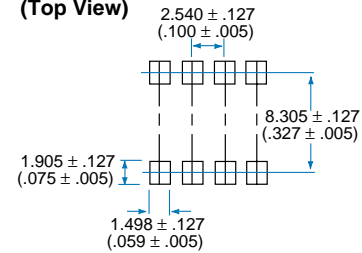

Tape and Reel Packaging for 8 Pin Surface Mount Package

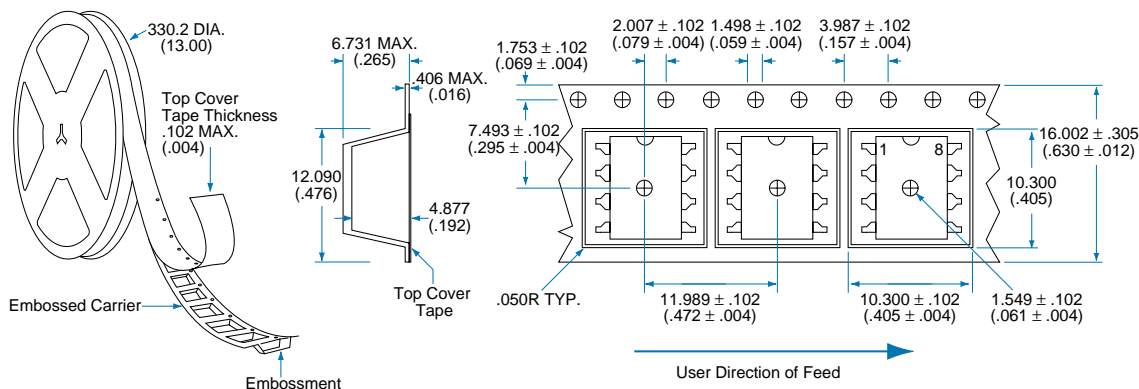

Dimensions
 mm
 (inches)

Mechanical Dimensions

8 Pin Flatpack ("P" Suffix)

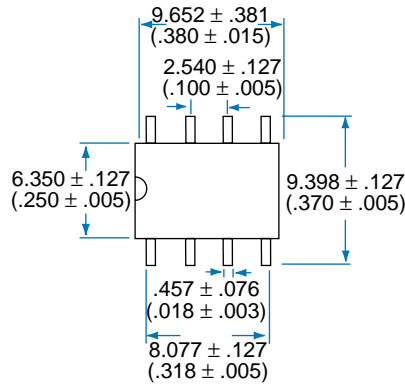
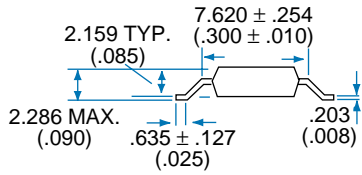

PC Board Pattern (Top View)

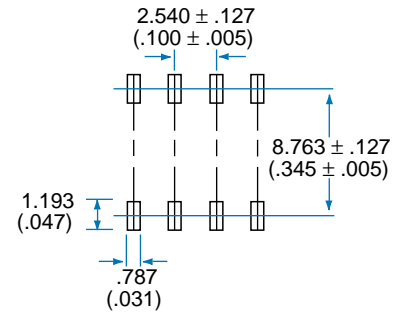

Tape and Reel Packaging for 8 Pin Flatpack Package

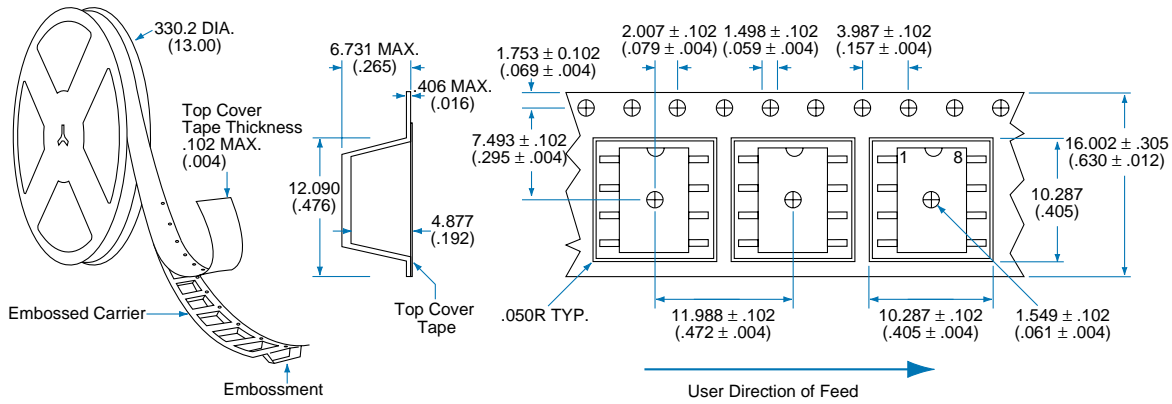

Dimensions
mm
(inches)



CLARE

For additional information please visit our website at: www.clare.com

Clare, Inc. makes no representations or warranties with respect to the accuracy or completeness of the contents of this publication and reserves the right to make changes to specifications and product descriptions at any time without notice. Neither circuit patent licenses nor indemnity are expressed or implied. Except as set forth in Clare's Standard Terms and Conditions of Sale, Clare, Inc. assumes no liability whatsoever, and disclaims any express or implied warranty, relating to its products including, but not limited to, the implied warranty of merchantability, fitness for a particular purpose, or infringement of any intellectual property right.

The products described in this document are not designed, intended, authorized or warranted for use as components in systems intended for surgical implant into the body, or in other applications intended to support or sustain life, or where malfunction of Clare's product may result in direct physical harm, injury, or death to a person or severe property or environmental damage. Clare, Inc. reserves the right to discontinue or make changes to its products at any time without notice.

Specification: DS-LCC110-R4.0
©Copyright 2002, Clare, Inc.
All rights reserved. Printed in USA.
6/25/02